



Liquid Bath Temperature Calibrator (CALsys 250) User's Guide



TEMPESENS INSTRUMENTS (I) PVT. LTD. UNIT II

A-190, Road No.5, M.I.A., Udaipur-313003 INDIA

Ph. : +91-294-3500600,

Fax : +91-294-3500631

Email : tech@tempsens.com

Web : www.tempsens.com

Legal Disclaimer

The information contained in this document is the property of TEMPSENS.

TEMPSENS reserves the right to make changes to this document and to the product described herein without notice. Before installing and using the product, review the latest version of the applicable documentation, which are available from the Tempsens website at:

<http://www.tempsens.com/>

© 2021 Tempsens Instrument Pvt. Ltd. All Rights Reserved.

Document Information

Name	Liquid Bath Temperature Calibrator (CALsys 250) User Manual
Document Version	1.0
Document Code	TS.CS.001
Publish Date	Monday, April 11, 2022

Table of Contents

Preface	5
Safety Information.....	5
Electrical Safety.....	6
Health and Safety Instructions.....	7
Cautions and Preventions.....	8
Document Conventions.....	8
Chapter 1	
Introduction	9
1.1 About CALsys 250.....	9
1.2 Basic Working Model of CALsys 250.....	10
1.3 Physical Measurements.....	11
1.4 Wiring Diagram.....	12
1.5 Technical Specifications.....	13
Chapter 2	
Setting Up CALsys 250	14
2.1 Installation.....	14
2.2 Optimal Environmental Conditions.....	14
2.3 Unpacking and Initial Inspection.....	15
2.4 Operating Instructions.....	16
2.5 Initial Testing.....	16
Chapter 3	
Installation of CALsys 250	17
3.1 Turning on the Unit.....	17
3.2 Heating up the source	17
3.3 Operating Instructions.....	18
3.4 Cooling down the source.....	19

Chapter 4

Operating CALsys 250.....	20
4.1 Front Panel Layout.....	20
4.2 The Temperature Controller.....	20
4.3 Altering the Set point.....	20
4.4 Monitoring the Controller Status	21
4.5 Temperature Units.....	21

Chapter 5

Digital Communication.....	22
5.1 Digital Communications Wiring.....	22
5.2 Digital Communications Parameters.....	23

Chapter 6

Software Installation.....	24
6.1 Installation.....	24
6.2 Parameters on main screen.....	24

Chapter 7

Service & Maintenance.....	26
7.1 Routine Service.....	26
7.2 Replace the Controlling Sensor.....	26
7.3 Replace Solid State Relay.....	26

Chapter 8

Troubleshooting CALsys 250.....	27
8.1 CALsys 250 unit does not turn on.....	27
8.2 CALsys 250 unit is not stable.....	27
8.3 The temperature of the calibrator does not rise.....	27

Appendix A : Calibration Services	28
In House Calibration Facility.....	28
On-site Calibration Facility.....	29
Fixed-Point Calibration Facility.....	29
Appendix B : Warranty	30
Limit of Liability.....	30
Caution in Using the Product.....	30

Preface

Welcome to the Liquid bath Temperature Calibrator (CALsys 250) user guide. This guide provides detailed information about all the product options and features, and explains how to use the product and configure basic settings to suit your requirements.

This user manual contains information about the product and its proper use and should be kept in a place where it will be easy to access. This user manual also provides safety precautions in using this product.

Safety Information

This topic contains important information regarding safety. Ignoring safety precautions may cause serious personal injury or damage to the unit and/or its components. Use the equipment only as specified in this manual. Otherwise, the protection provided by the instrument may be impaired.





Refer to the safety information in the Electrical Safety and Health and Safety Instructions sections or wherever specified in this manual.

In order to assure the device operates safely, the operator needs to act effectively and be conscious of safety problems.

The following definitions apply to the terms **“Warning”** and **“Caution”**.

- **“Warning”** identifies conditions and actions that may pose hazards to the user.
- **“Caution”** identifies conditions and actions that may damage the instrument being used.

The following safety symbols may appear on CALsys 250 unit:

SYMBOL	DESCRIPTION	SYMBOL	DESCRIPTION
	Risk of Danger. Important information. See Manual		Hazardous voltage. Risk of electric shock
	Caution, Hot Surface		Protective Earth Ground

Electrical Safety

WARNING:

- **This equipment must be correctly grounded before use. Make sure the ground conductor wire (colored green/yellow) in the main power cable is connected to a protective earth/ground. If the equipment is not properly grounded, the high voltage may flow through the equipment body (chassis). SEVERE INJURY OR DEATH may result if personnel fail to observe safety precautions.**
 - **Do not remove the panels from the equipment without proper safety measures to avoid internal main power supply voltage hazard.**
-

To avoid possible electric shock or personal injury, follow these guidelines.

- ⊕ This equipment uses protective earth circuit to ensure that the conductive parts do not store electric charges or conduct electricity if insulation fails.
- Before connecting the equipment to the electricity supply, understand the parts of the calibrator with the help of operating manual.
- Use power cables only with appropriate voltage and power rating, and that are approved for usage in your country.
- Replace the main power cable if the insulation is damaged, or if the insulation shows signs of wear and tear.
- DO NOT put the product at the location where access to the main power is blocked.
- DO NOT use an extension cord or adapter plug.
- DO NOT use the product if it operates incorrectly.
- Make sure the power cord does not touch the hot parts of the product.

Health and Safety Instructions

 **WARNING: BURN HAZARD - DO NOT touch the well access surface of the unit at high temperature**

To avoid possible health and safety concerns, follow these guidelines.

- Wear appropriate protective clothing before using the equipment.
- Operators of this equipment should be adequately trained in the handling of hot and cold items and liquids.
- Do not use the apparatus for jobs other than those for which it was designed, that is, the calibration of thermometers.
- Do not handle the apparatus when it is hot (or cold), without wearing the appropriate protective clothing and having the necessary training.
- Do not drill, modify or otherwise change the shape of the apparatus.
- Do not use the apparatus outside its recommended temperature range.
- After use, do not return the apparatus to its carrying case until the unit has cooled down.
- There are no user serviceable parts inside. When required, contact Tempsens agent for repair.
- Ensure all materials, especially flammable materials are kept away from the hot parts of the apparatus, to prevent fire risk.
- Do not use the product around explosive gas, vapor, or in damp or wet environments.
- Make sure that the space around the product meets minimum space requirements.
- DO NOT turn off the unit at temperatures higher than 50°C. This could create a hazardous situation. Select a set-point less than 50°C and allow the unit to cool before turning it off.
- The top sheet metal of the furnace may exhibit extreme temperatures for areas close to the well access.
- Materials used in this furnace may be irritating to skin, eyes, and respiratory tract. Consult the material manufacturer's Material Safety Data Sheet (MSDS) to learn about those materials before using.





Cautions and Preventions

To avoid possible damage to the instrument, follow these guidelines:

- Before working inside the equipment, turn the power off and disconnect the power cord.
- DO NOT turn the unit upside down with the inserts in place; the inserts will fall out of the unit.
- Use of this instrument at HIGH TEMPERATURES for extended periods of time requires caution.
- Completely unattended high temperature operation is not recommended for safety reasons.
- DO NOT plug the unit into 230 V if the heater switches and fuse holder reads 115 V. This action will cause the fuses to blow and may damage the instrument.
- Components and heater lifetime can be shortened by continuous high temperature operation.
- DO NOT use fluids to clean out the well.
- Never introduce foreign material into the probe hole of the insert. Fluids and other materials can leak into the calibrator causing damage.
- DO NOT drop or force the probe stems into the well. This type of action can cause a shock to the sensor and affect the calibration.

Document Conventions

The documentation uses the following conventions.

 Note:	Configuration notes
 Tip:	Recommendations or suggestions
 Important:	Information regarding required or default configuration settings and product limitations
 WARNING:	Critical actions and configuration options
 WARNING:	

Chapter 1

Introduction

1.1 About CALsys 250

The 'CALsys 250' has been designed to provide stable and accurate temperature to enable professionals to calibrate Temperature Sensing Devices by comparison method. The 'CALsys 250' model has been designed to be rugged and easily maintained. This model provides an isothermal enclosure in which the thermocouple/RTD can be calibrated against the temperature of the calibrator. For traceable calibration a master calibration sensor should be placed into the bath alongside the unit under calibration. The method is widely accepted because the calibrator provides very stable temperature nearing to its controlled point, the Master Thermocouple / RTD, which is calibrated by independent Laboratory traceable to National standards, compares the sensor under calibration.

The 'CALsys' models are part of wide range of portable calibrators designed and made by us.

The CALsys models are part of wide range of portable calibrators designed and made by Tempsens.

Contact Tempsens to learn more about other products by Tempsens.



CALsys 250

1.2 Basic Working Model of CALsys 250

The calibrator controller uses a PT-100 sensor as a controlling sensor and controls the chamber temperature with Tubular Heater. To obtain and maintain a required temperature the controller varies the power to the heater via solid-state relay. There is one electricity driven fan which is situated under the heating chamber for cooling the heater. The CALsys 250 Liquid calibrator was designed for portability, moderate cost and ease of operation. With proper use the instrument should provide continued accurate calibration of temperature sensors and devices. The user should be familiar with the safety guidelines and operating procedures of the calibrator as described in the User's Manual.

! Important:

Before using the equipment, read the safety guidelines and operating procedures of the calibrator as described in the **Preface** of this user manual.

The basic working model for CALsys 250 is as follows:

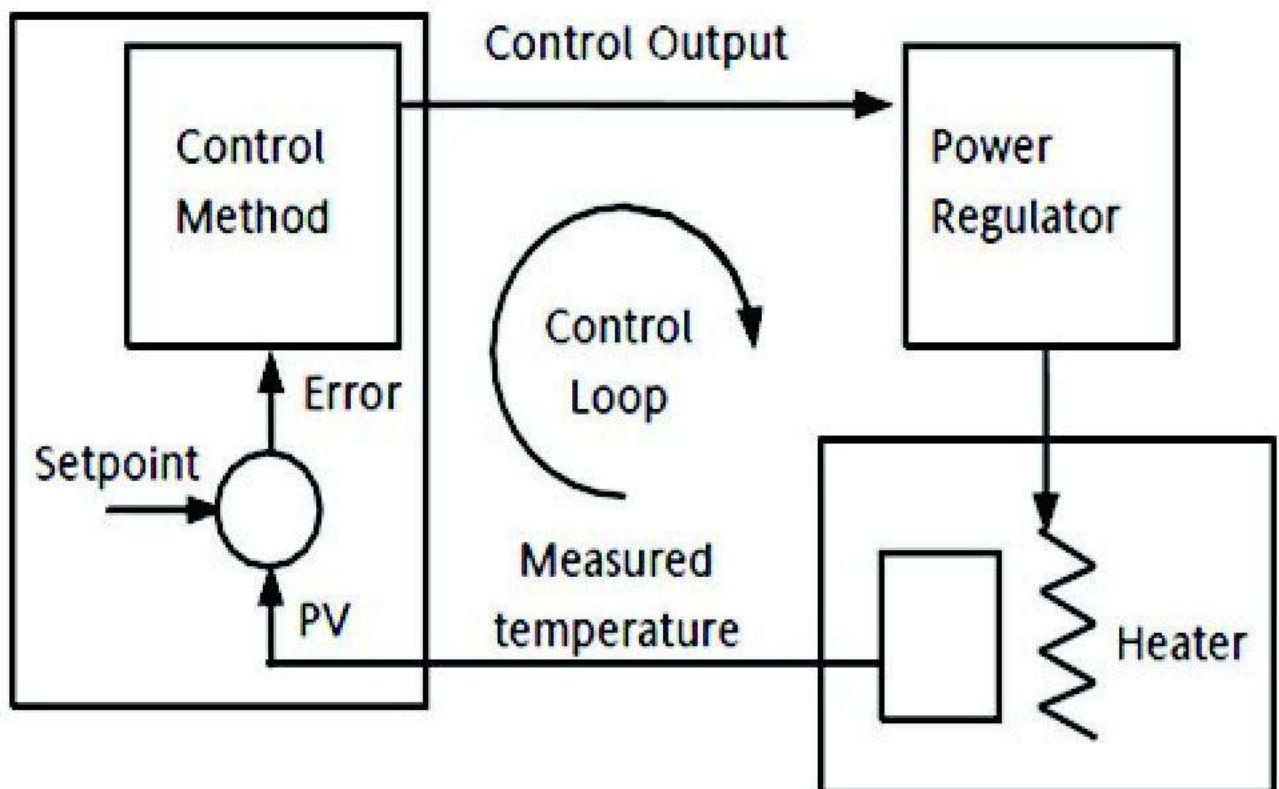

1.3 Physical Measurement

CALsys 250 has the following physical measurements:

- Height: 309mm
- Width: 253mm
- Depth: 327mm

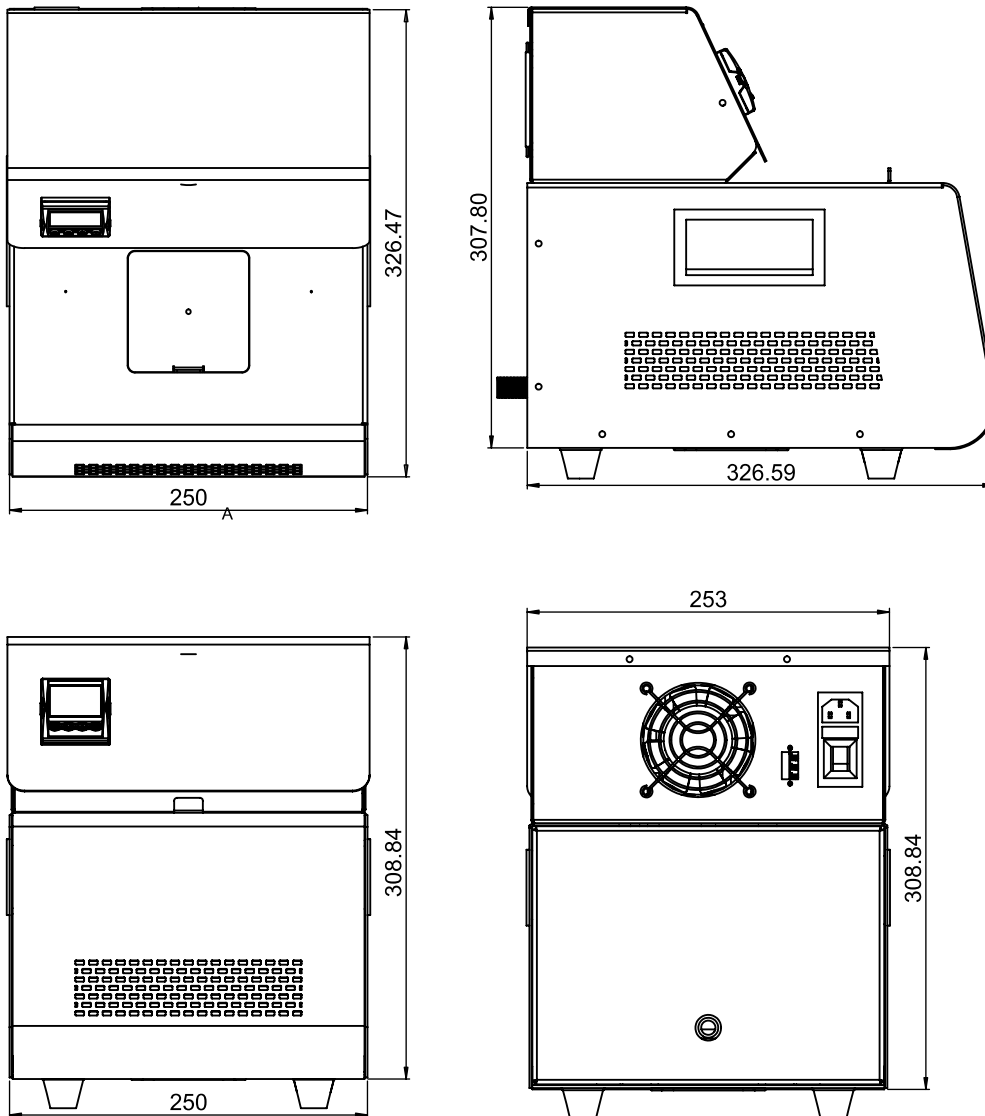

1.4 Wiring Diagram

Refer to following figure for CALsys 250 wiring diagram.

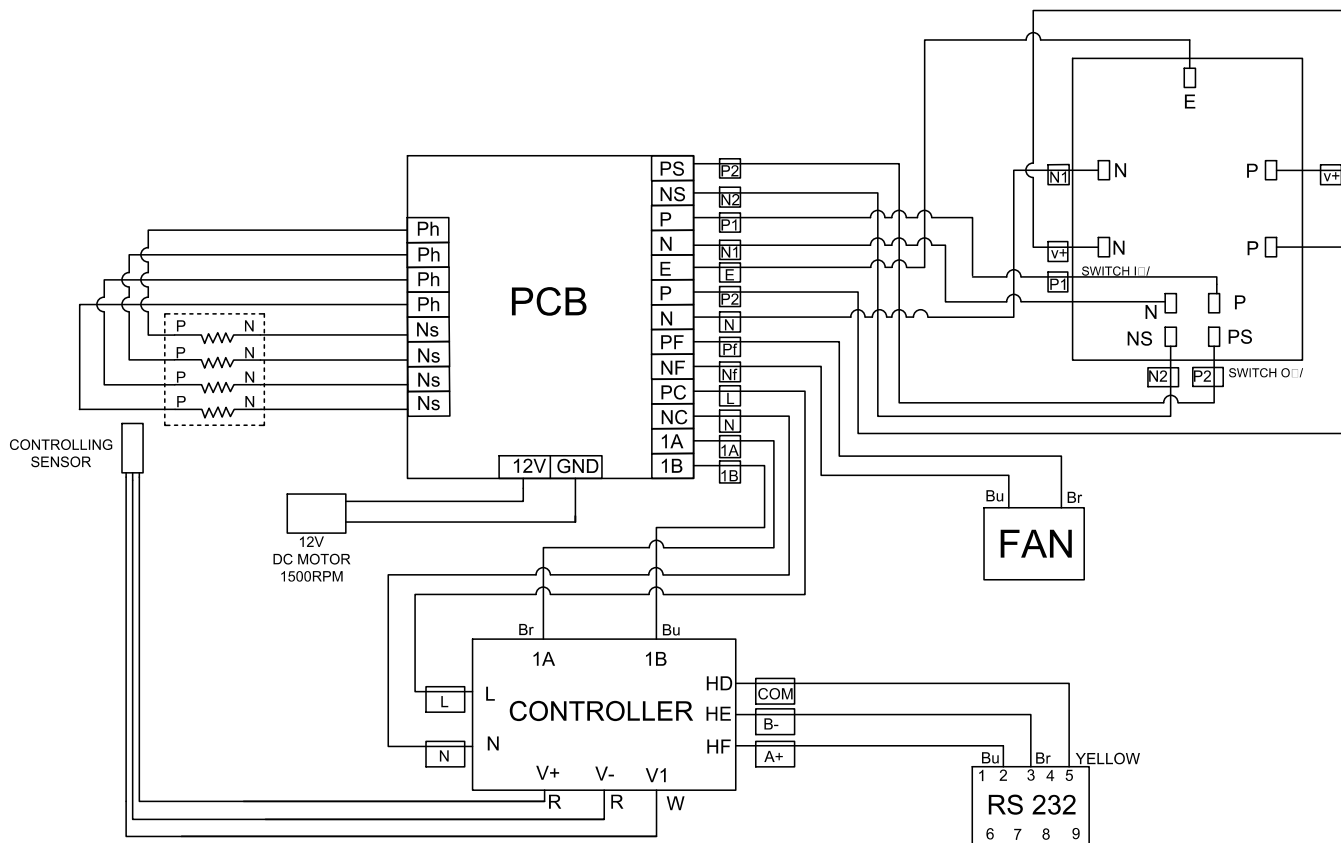

1.5 Technical Specification

CALsys 250 has the following technical specifications:

PARAMETER	SPECIFICATION
Temperature Range	50°C to 250°C
Accuracy	±0.5°C
Stability	± 0.01°C at 50 °C ± 0.02°C at 150 °C ± 0.03°C at 250 °C
Uniformity	± 0.02°C at 50 °C ± 0.04°C at 150 °C ± 0.06°C at 250 °C
Removable insert construction	6 holes of 15mm dia
Volume	2 Ltr.
Method of Control	Self tuned PID controller
Immersion depth	140mm
Access opening	80x80 mm
Heating time	30 Min
Coling time	60 Min (250°C to 100°C)
Resolution	0.1°C
Power requirements	230VAC, 2KW (50Hz)
Display	LCD, °C or °F user-selectable
Size (H x W x D)	330(H) x 250(W) x 350(D) mm
Weight	12kg
Power requirments	230 VAC, 1.5 KW (50 Hz)
Computer Interface	RS - 232
Calibration	Accredited calibration certificate provided
Environment operating conditions	0°C to 40°C, 0% to 90% RH (non-condensing)
Specifications valid in environmental conditions	13°C....33°C

Chapter 2

Setting up CALsys 250

2.1 Installation

Place the liquid bath on a flat surface with at least 10 inches of free space around the instrument. Overhead clearance is required.

DO NOT Place this unit under a cabinet or structure. Plug the power cord into a grounded mains outlet located on the controlling unit rear panel. Observe that the nominal voltage corresponds to that indicated in the technical specifications in [Technical Specifications](#) in [Chapter 1](#) of this user's guide.

2.2 Optimal Environmental Conditions

•Although the instrument has been designed for optimum durability and trouble-free operation, it must be handled with care. The instrument should not be operated in an excessively dusty or dirty environment. Refer to [Chapter 7, Service & Maintenance](#) in this user's manual for routine service and cleaning recommendations

.The instrument operates safely under the following conditions:

- Temperature range: 5 - 50°C (41 - 122°F)
- Ambient relative humidity: 15 - 50%
- Pressure: 75kPa - 106kPa
- Main voltage supply within $\pm 10\%$ of nominal voltage range
- Vibrations in the calibration environment should be minimized
- Altitude less than 2000 meters

2.3 Unpacking and Initial Inspection

•CALsys 250 is packed in custom-designed packaging to send out your unit. Unpack the furnace carefully. Inspect the unit after unpacking for any signs of damage, and confirm that your delivery is in accordance with the packing note. If you find any damage to the unit or an item is missing, notify Tempsens immediately. The following accessories are included in the package:

- CALsys 250
- Power cord
- RS-232 Cable
- External Reference Sensor (RTD)
- Manual
- Certificates

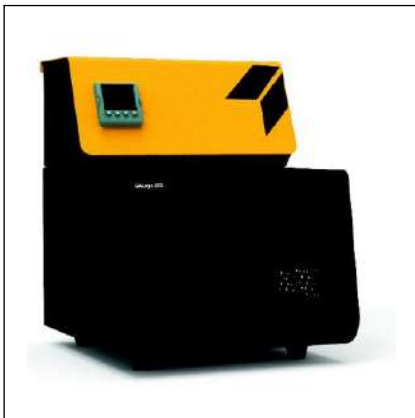

CALsys 250



RTD

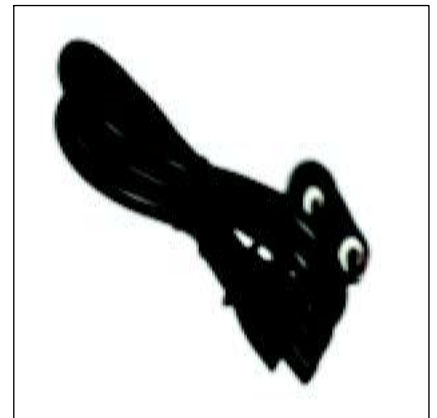

Power Cable



RS-232 Cable



Insulation Wool

2.4 Operating Instructions

1. Open the carrying case carefully and take out the operating manual from the box and read carefully.
2. Take out the Temperature Calibrator unit carefully and keep it at suitable place.
3. Connect the power cable to the rear power entry and the power plug to the main power outlet.
4. Turn the switch on, and observe the display on the controller. The display shows that the bath is ready for use.
5. Keep the switch in the ON position.
6. Ensure the Sensor Holder is properly inserted in the bath.
7. Keep the fan in on position.
8. If the fan is running and temperature of the furnace is rising, the bath is in healthy condition.



Note:

- The unit must be correctly connected to the electricity supply.
- The unit must be correctly grounded. ⚡
- The unit's ON/OFF switch is located on the power inlet. DO NOT switch OFF the unit when it is hot. Keep the unit running until cooled.

2.5 Initial Testing

This unit is fully tested before dispatching. However, verify its operation as follows:

1. After connecting the CALsys 250 to the electricity supply, the temperature controller display should show the temperature of the chamber, and the last set-point value. The fan at the back should be heard running.
2. Change the set-point to 100°C and observe that the bath temperature rises and settles to this value.
3. If the unit performs as expected, the unit can now be used for calibration.

If any problems or faults arise during the test, contact Tempsens immediately for help and advice.

Chapter 3

Operating CALsys 250

3.1 Turning On the unit

1. Before plugging the unit to main power outlet, ensure that the voltage, frequency and current from the main power outlet are within the recommended ranges (typically: 230 VAC \pm 10, 50/60 Hz).
2. Plug the black main power cord into main outlet.
3. Turn the controller on using the switch located on the controlling section, and set the temperature value in the controller. The Calibrator will turn on and begin to heat the previously programmed temperature set-point.



3.2 Heating up the source

Press “UP” or “DOWN” key of controller to change the set-point value. The controller switches the calibrator heater to ON or OFF to raise or lower the temperature. The displayed temperature will gradually change until it reaches the set-point temperature.

The Calibrator may require 15 to 20 minutes to reach the set-point depending on the span. The unit takes 15 to 20 minutes more to stabilize the bath temperature within $\pm 0.1^{\circ}\text{C}$ of the set-point.



Note:

- All other controller parameters are set to default, and are locked. It is recommended not to change these parameters

! Important:

- When the source is operated at any temperature above ambient temperature, the front face and plate become hot.
- Always put the fan in "ON" condition and do not switch off the main power supply directly. Before tuning the unit off, set the controller to 0°C, and then wait until the temperature drops below 100°C.

3.3 Operating Instruction

1. Fill the liquid approx 70% of inner chamber volume.
2. Place the sensor holder in the bath.
3. Place the sensors for calibration and master sensor into a suitable insert hole.
4. Set the controller to the required temperature.
5. If test and master sensor are thermocouple, then always use compensating cable (for each type such as J, K, T, E, N, R, S, B) for interconnection between sensor and Digital Multimeter (DMM).
6. Keep reference junction at 0°C. If keeping at 0°C is not possible, then add millivolt (mV) of room (ambient) temperature with sensors output (mV) to compensate the ambient temperature.
7. When controller temperature becomes stable, record the reading from DMM with at least 4 1/2 digit precision, which should be calibrated for the measuring range (mV & ohms measurements).
8. Find out the error by comparison method.
9. Reset the controller and/or repeat the calibration for another calibration point or for another sensor.
10. When the calibration is completed, reset the controller to 0°C. Before moving CALsys 250 to new location the unit must be cooled to below 100°C.

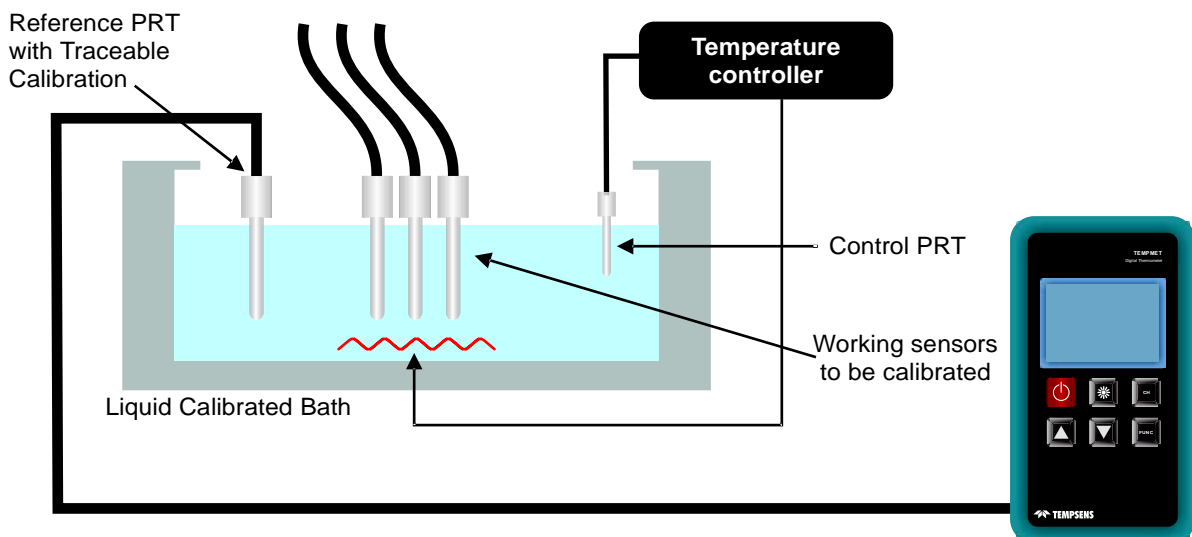

**Note:**

- Sensor holder should be required hole size so that the hole size is suitable for sensor under calibration.
- Always use a master sensor (master RTD/TC) for comparison calibration method.
- Place the sensor holder first in all sensors, and then set the controller at desired set point.
- Check that all sensors (test and master) are immersed at same depth in insert (bath).
- If sensors are not immersed at same depth than there will be an error in temperature reading.
- Always use a bath calibrator (insert). bath calibrator heat transfer characteristics should match with those in the normal measuring situations.
- The temperature sensors should be long enough to immerse completely in the calibration bath. Errors due to stem conduction can be ignored.
- Do not change the set temperature value too often. For example, you set the temperate initially at 100°C, and when it reaches at 80°C, you change the temperature to 150°C. Or, you set the temperature initially at 150°C, and when it reaches close to 150°C, you change the temperature to 100°C. Doing so may affect unit's performance.
- Plan the calibration point by gradually increasing temperature, then set the controller accordingly. This method will save the time.
- Take the reading of sensors (master and test) at stable temperature with the help of digital multi-meter, or by using Tempsens' TEMPMET 08 or TEMPMET 09 for reading RTD or TC sensor

3.4 Cooling Down the Source

- Before transporting the bath, ensure that the temperature of bath has cooled sufficiently.
- If you require bath to cool quickly, set the temperature to the room temperature (ambient temperature).
- Always cool the heated instrument to ambient temperature before disconnecting it from the mains, switching it OFF, or removing the temperature sensor or test item.
- Always keep the heated instrument supervised and under observation until it cools down sufficiently.

Chapter 4

Operating Unit Controller

4.1 Front Panel Layout

The following image shows the front panel of CALsys 250

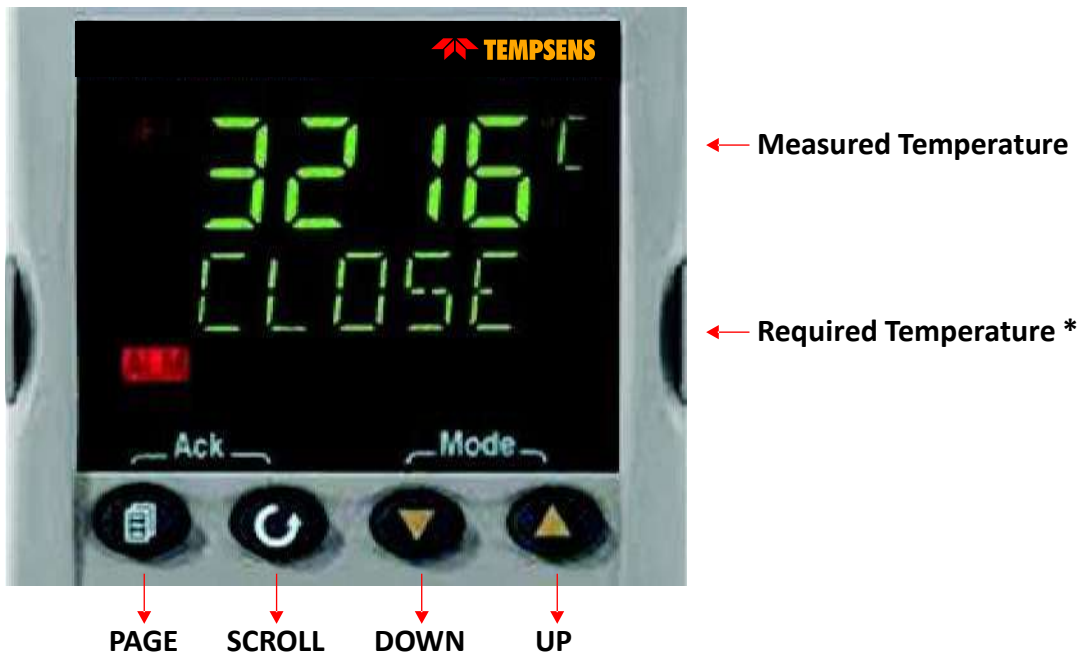

4.2 The Temperature Controller

The controller has a dual display, the upper display indicates the measured temperature, and the lower display indicates the desired temperature or set point.

4.3 Altering the Set point

To change the set point of the controller simply use the UP and DOWN keys to raise and lower the set point to the required value. The lower display changes to indicate the new set point.

4.4 Monitoring the Controller Status

A row of beacons indicates the controllers status as follows:

- OP1: Heat Output
- OP2: Cool Output (only for models which operate below 0°C)
- REM: This beacon indicates activity on computer interface

4.5 Temperature Units

Press the Scroll key to show the controller units in °C or °F.

Chapter 5

Digital Communication

Digital Communication allows the controller to communicate with a PC or a networked computer system through RS-232 (or EIA232) protocol. RS-232 (or EIA232) is a standard communication protocol for linking computer and its peripheral devices to allow serial data exchange. RS-232 communication is not available if Remote Set point is fitted. The cable screen should be grounded at one point only to prevent earth loops.

5.1 Digital Communications Wiring

To use EIA232 (or RS-232), the PC will be equipped with an EIA232 port, usually referred to as COM 1. To construct a cable for EIA232 operation use a three core screened cable. The terminals used for EIA232 digital communications are listed in the table below. Some PC's use a 25-way connector although the 9 way is more common.

STANDARD CABLE COLOR	PC SOCKET PIN NO.		PC FUNCTION*	INSTRUMENT TERMINAL	INSTRUMENT FUNCTION
	9 WAY	25 WAY			
White	2	3	Receive (RX)	HF	Transmit (TX)
Black	3	2	Transmit (TX)	HE	Receive (RX)
Red	5	7	Common	HD	Common
Link Together	1	6	Received line signal detect		
	4	8	Data terminal ready		
	6	11	Data set ready		
Link Together	7	4	Request to send		
	8	5	Clear to send		
Screen		1	Ground		

*These are the functions that are normally assigned to socket pins. Check your PC manual to confirm.

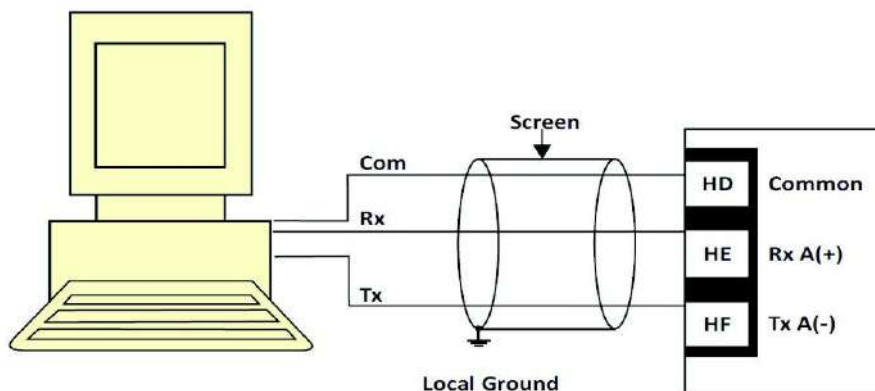

5.2 Digital Communications Parameters

The following table shows the available parameters.

DIGITAL COMMUNICATION LIST (COMMS)						
NAME	SCROLLING DISPLAY	PARAMETER DESCRIPTION	VALUE		DEFAULT	ACCESS LEVEL
ID	MODULE IDENTITY	COMMUNICATION IDENTITY	NONE	NO MODULE FITTED	AS ORDER CODE	CONF L3 R/O
			R232	RS232 MODBUS INTERFACE		
			R485	EIA485 MODBUS INTERFACE		
			R422	EIA422 MODBUS 3216 ONLY		
			DC,P	REMOTE SET-POINT INPUT. IF FITTED THIS ID REPLACES THE ABOVE AND NO FURTHER PARAMETERS ARE SHOWN		
ADDR	COMMUNICATION ADDRESS	COMMUNICATION ADDRESS OF THE INSTRUMENT	1 TO 254		1	L3
BAUD	COMMUNICATION BAUD RATE	COMMUNICATION BAUD RATE	1200	1200	9600	
			2400	2400		
			4800	4800		
			9600	9600		
			19.20	19.20		
PRTY	COMMUNICATION PARITY	COMMUNICATION PARITY	NONE	NO PARITY	NONE	
			EVEN	EVEN PARITY		
			ODD	ODD PARITY		
DELAY	RX/TX DELAY TIME	TO INSERT A DELAY BETWEEN RECEIVER (Rx) AND TRANSMITTER (Tx) TO ENSURE THAT DRIVERS HAVE SUFFICIENT TIME TO SWITCH OVER.	OFF	NO DELAY		CONF L3 R/O
			ON	FIXED DELAY APPLIED		
RE TRAN	COMMS RETRAN MISSION	MASTER COMMS BROADCAST PARAMETER SEE SECTION 15.2.1	NONE	NONE	NONE	
			WSP	WORKING SETPOINT		
			PU	PROCESS VARIABLE		
			OP	OUTPUT DEMAND		
			ERR	ERROR		
REGAD	COMMS RETRAN MISSION ADDRESS	PARAMETER ADDED IN SLAVE ADDRESS TO WHICH THE MASTER COMMUNICATION VALUE WILL BE WRITTEN	0 TO 9999			

Chapter 6

Software Installation

The provided Tempsens software offers possibilities to connect furnace temperature bath and change set point, maximum time span, view real time graph and evaluate measuring data.

6.1 Installation

Install the calibration software using the installation guide file on CD ROM. After installing the software, start the application. **CalSoft Tempsense Instruments** screen appears, as shown in - Main Screen *Figure 1*

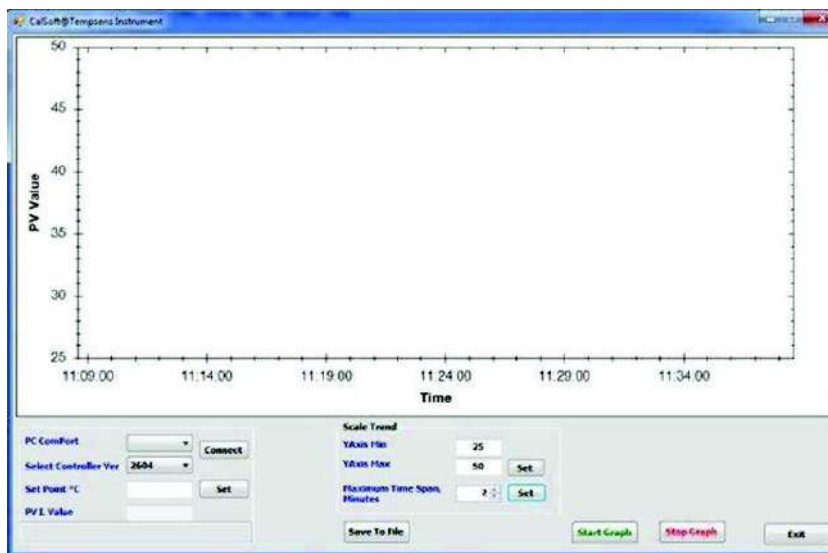

Figure 1 - Main screen



Figure 2 - PC ComPort



Figure 3 - Controller Version

6.2 Parameters on Main Screen

Communication between the furnace and the software is implemented via USB cable connected between the furnace and the PC serial port. This enables the acquisition and recording of data, as well as the transfer of commands from the software application to the Tempsens furnace.

To communicate between the furnace and software application, select correct **COM port** (as shown in *Figure 2*) and Controller Version (**3216**) (as shown in *Figure 3*), and then click **Connect**.

To set the temperature of furnace as per your requirement, type the required temperature in **Set Point (°C)** field, and click **Set**.

PVI Value displays the current present value of furnace temperature.

The **Scale Trend** section enables you to configure **Y-Axis Min** (minimum value: 0), **Y-Axis Max** (maximum value: 1500), **Maximum Time Span** of data logging up to 120 minutes, and then click the **Start Graph** button. After completing the task, click Save To File to save settings to file. See *Figure 4*



Figure 4 - Scale Trend Window

File will be stored in .xls format to save previous record. See *Figure 5*.

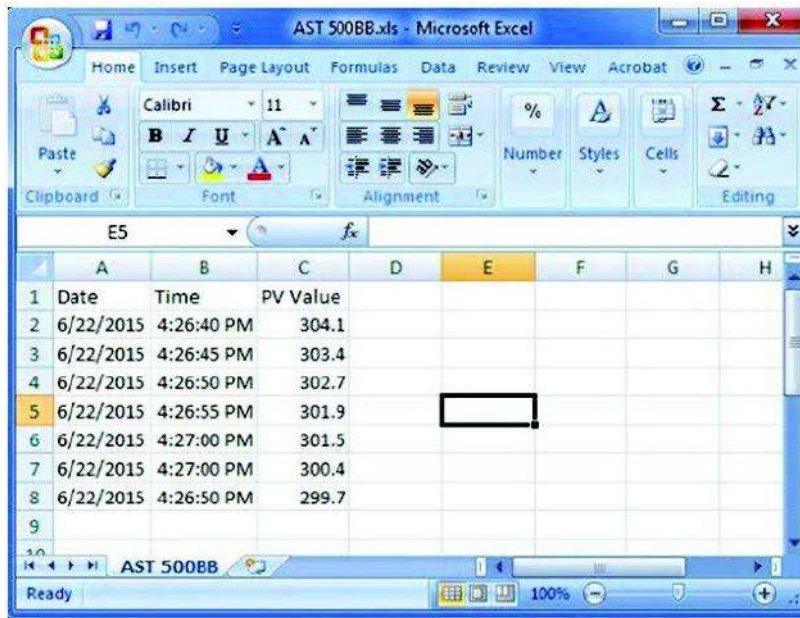

The image shows a Microsoft Excel spreadsheet titled "AST 500BB.xls". The spreadsheet has a table with the following data:

	A	B	C	D	E	F	G	H
1	Date	Time	PV Value					
2	6/22/2015	4:26:40 PM	304.1					
3	6/22/2015	4:26:45 PM	303.4					
4	6/22/2015	4:26:50 PM	302.7					
5	6/22/2015	4:26:55 PM	301.9					
6	6/22/2015	4:27:00 PM	301.5					
7	6/22/2015	4:27:00 PM	300.4					
8	6/22/2015	4:26:50 PM	299.7					
9								

Figure 5 - Record in .xls Format

Chapter 7

Service & Maintenance

7.1 Routine Service

Turn the electricity supply off before attempting any cleaning operation. The only moving part in this unit is fan, which is sealed for life.

Depending on the environment in which **CALsys 250** is used, periodic cleaning is recommended. Cleaning may be accomplished by the use of a small dry paint brush. The instrument should be periodically checked to ensure it is in good order both mechanically and electrically.

7.2 Replace the Controlling Sensor

Use the following steps to replace the controlling RTD sensor in the Calibrator Unit:

1. Disconnect the Calibrator Unit is from electrical supply.
2. Remove the cover of the Calibrator Unit.
3. Disconnect the RTD from the connector block.
4. Remove the RTD from the heating chamber present inside by unscrewing the fitting.
5. Insert and fit the new RTD into the heating chamber.
6. Reconnect the new RTD to the connector block.
7. Place the cover back on the Calibrator Unit.
8. Reconnect the furnace to the electrical supply.

7.3 Replace Solid State Relay

Use the following steps to replace the sod state relay in the Calibrator Unit:

1. Disconnect the Calibrator Unit from the electrical supply.
2. Remove the cover of the furnace.
3. Locate the solid state relay.
4. Note down the wire positions and then disconnect the wires.
5. Remove the faulty relay and replace it with a new one.
6. Tighten the fixing screws.
7. Refit the wires back in position as you noted in step 4 of this procedure.
8. Place the cover back on the Calibrator Unit.
9. Reconnect the furnace to the electrical supply.

Chapter 8

Troubleshooting CALsys 250

8.1 CALsys 250 unit does not turn on

If the CALsys 250 unit does not turn on or operate as usual, check if the fuse is broken, and replace the fuse if necessary. If the fuse breaks repeatedly, contact Tempsens for technical support.

8.2 The CALsys 250 unit is not stable

If the CALsys 250 is not stable or the temperature varies too often, the control parameters might have been modified. If this happens, contact Tempsens for technical support.

8.3 The temperature of the calibrator does not rise

If the temperature of the Calibrator Unit does not rise, ensure the following:

1. The power cord is tightly fitted at the power entry location on the Calibrator Unit.
2. The power switch is turned ON.

If the temperature of the Calibrator Unit still does not rise even after you have inspecting and fitting the power cord and power switch, the reason can be one of the following:

- The heating element is not firmly closed. If the heating element is open, close it properly.
- The thermocouple is not firmly closed. If the thermocouple is open, close it properly.
- The Controller Unit may be not display correct reading.
- The SSR is damaged.

If the Calibrator Unit does not function properly, contact Tempsens immediately for technical support.

Appendix A: Calibration Services

Tempsens Calibration Center is an independent unit of Tempsens instruments (I) Pvt. Ltd, having laboratories at Udaipur, Vadodara & Bangalore. It is accredited for wide range of temperature calibration services.

It is the only private sector Laboratory in the country with accredited Fixed Point Temperature Calibration Facilities. The lab has highly stable calibration furnaces, measuring instruments and accurate master sensors traceable to National and International Standards.

The calibration center functions as per ISO 17025 / NABL standards. Calibration of contact type sensors can be made in temperature range of -196°C to 1600°C and Calibration of non-contact type sensors can be made in temperature range 0°C to 2900°C. Further the laboratory is accredited for onsite temperature calibration.

The lab offers both at Lab & On-Site Calibration of Furnace/Bath from -80°C to 1600°C and Black Body Calibration from 50°C to 1700°C.

Furnace/Chamber Calibration (TUS) with multiple sensors from -80°C to 1200°C is also in the scope of the lab.

In House Calibration Facility

QUALITY MEASURED / INSTRUMENTS	TEMPERATURE RANGE	CALIBRATION & MEASUREMENT CAPABILITY
Contact Type RTD, Thermocouples Thermometers	-196°C	0.05°C
	-80 to -38°C	0.03°C
	-38°C to 0°C	0.03°C
	>0°C to 140°C	0.04°C
	>140°C to 250°C	0.04°C
	>250°C to 650°C	0.12°C
	>650°C to 1200°C	1.30°C
>1200°C to 1600°C	2.60°C	
Non-Contact Type Pyrometer	0°C to 250°C	1.5°C
	>250°C to 500°C	2.4°C
	>500°C to 1500°C	2.5°C
	>1500°C to 1700°C	3.2°C
	>1700°C to 2900°C	4.0°C

On-site Calibration Facility

QUALITY MEASURED / INSTRUMENTS	TEMPERATURE RANGE	CALIBRATION & MEASUREMENT CAPABILITY
Contact Type RTD, Thermocouples Thermometers	-25°C to 0°C >0°C to 140°C >140°C to 250°C >250°C to 650°C >650°C to 1200°C	0.07°C 0.04°C 0.09°C 0.12°C 1.30°C
Non-Contact Type Pyrometer	0°C to 250°C >250°C to 500°C >500°C to 1200°C	1.50°C 2.40°C 2.5°C
Multipoint Position Calibration of Chamber, Oven, Furnaces (Thermal Mapping(TUS))	-80°C to 200°C >200°C to 1200°C	2.8°C 4.1°C

Fixed-point Calibration Facilities

QUALITY MEASURED / INSTRUMENTS	TEMPERATURE RANGE	CALIBRATION & MEASUREMENT CAPABILITY
Calibration of SPRT/PRTS/thermocouple and so on.	Triple Point of Water (0.01°C) Melting Point of Gallium (29.7646°C) Freezing Point of Tin (231.928°C) Freezing Point of Zinc (419.527°C) Freezing Point of Aluminum (660.323°C)	0.0038°C 0.0065°C 0.0065°C 0.0071°C 0.0075°C
Calibration of Thermocouple at Secondary Fixed Point	Melting Point of Gold (1064.18 °C) >1500°C to 1700°C >1700°C to 2900°C	0.72°C 2.5°C 3.2°C 4.0°C
	Melting Point of Palladium(1554.8	0.83°C

Appendix B: Warranty

This instrument has been manufactured to exacting standards and is warranted for twelve months against electrical breakdown or mechanical failure caused through defective material or workmanship, provided the failure is not the result of misuse. In the event of failure covered by this warranty, the instrument must be returned, carriage paid, to the supplier for examination and will be replaced or repaired at our option.

FRAGILE CERAMIC AND/OR GLASS PARTS ARE NOT COVERED BY THIS GUARANTEE

INTERFERENCE WITH OR FAILURE TO PROPERLY MAINTAIN THIS INSTRUMENT MAY INVALIDATE THIS GUARANTEE

Limit of Liability

TEMPESENS is not liable for any damages that arise from the use of any examples or processes mentioned in these Specifications are subject to change without notice.

Caution in Using the Product

TEMPESENS PRODUCTS ARE INTENDED FOR USE BY TECHNICALLY TRAINED AND COMPETENT PERSONNEL FAMILIAR WITH GOOD MEASUREMENT PRACTICES.

IT IS EXPECTED THAT PERSONNEL USING THIS EQUIPMENT WILL BE COMPETENT WITH THE MANAGEMENT OF APPARATUS WHICH MAY BE POWERED OR UNDER EXTREMES OF TEMPERATURE, AND ARE ABLE TO APPRECIATE THE HAZARDS WHICH MAY BE ASSOCIATED WITH, AND THE PRECAUTIONS TO BE TAKEN WITH, SUCH EQUIPMENT



www.tempsens.com

TEMPSENS INSTRUMENTS (I) PVT. LTD.

Tempsens Instruments (I) Pvt. Ltd. U# II
A-190, Road No.5, M.I.A., Udaipur india

Ph. : +91-294-3500629(D), 3500600, **Fax :** +91-294-2500650

Email : tech@tempsens.com